

INSTALLATION, OPERATION AND MAINTENANCE INSTRUCTIONS FOR Recessed Warm Air Curtain Heaters

Catalogue Number RAC6000 (6 kW)

PLEASE RETAIN THIS LEAFLET FOR FUTURE MAINTENANCE



MODELS

The unit is 900mm 6 kW modular recessed heater designed for mounting above doorways and similar entrances to fit directly into a modular ceiling grid in a suspended ceiling, and may be used as space heaters. (Minimum ceiling height of 2.2m: maximum height 2.8m).

Weight: 14kg

MOUNTING

When fitting ensure that the air discharge is situated as close to the door as possible. The recessed air curtains are designed to fit directly into any suspended ceiling, especially ceiling tile grid formation. If the grid does not align with the door then it will need modifying.

The unit should be mounted so that the airflow is not obstructed by any part of the doorframe.

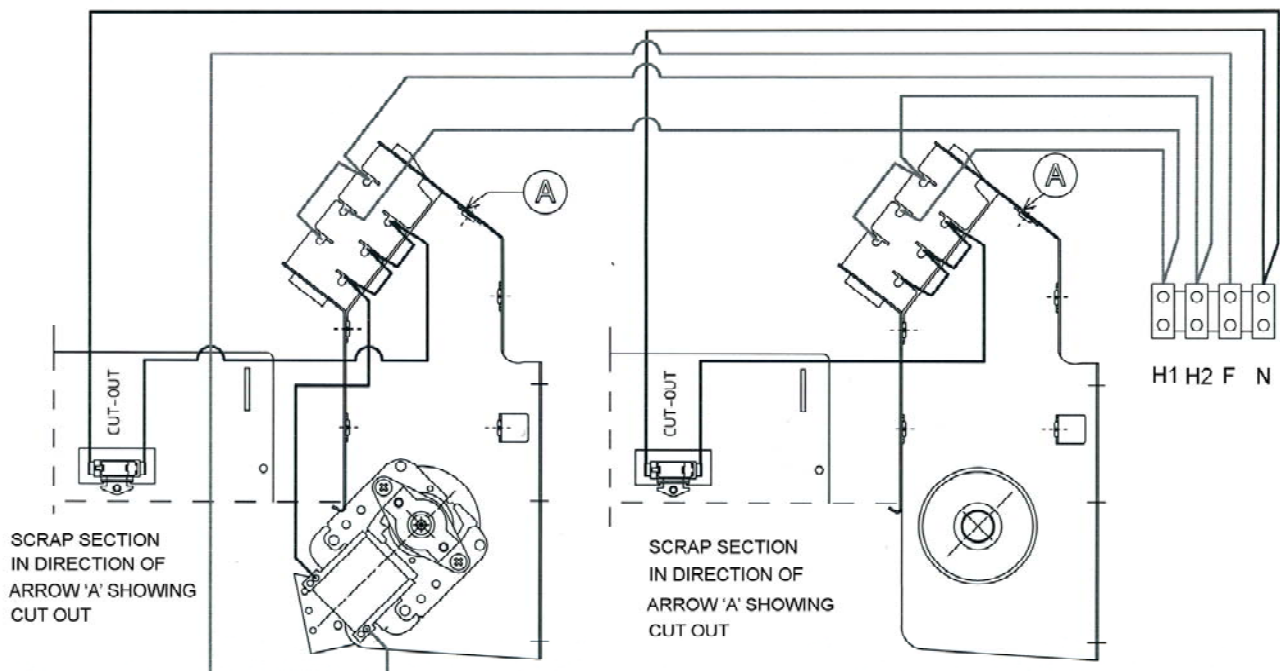

RAC6000 - 6.0 kW

INSTALLATION

To install the unit first remove the unit grille, see figure 1. (The control switch box is packed inside the unit. Remove the switch control box and retain for future 'Electrical Connection')

If mounted above a door the unit should be installed so that the outlet grille is nearest the doorway (directional arrows shown inside unit).

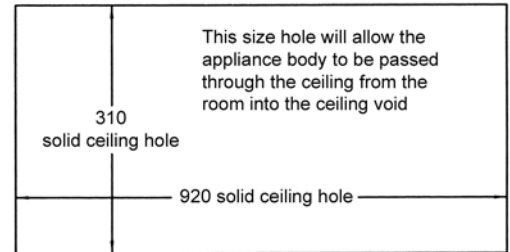
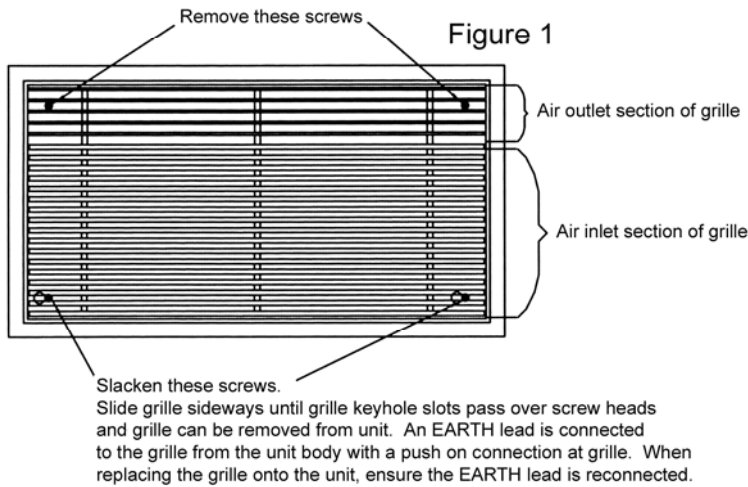

Figure 2

Each unit has 2 fixing brackets, see figures 3 and 4, from which it is suspended. Suspend the unit by threaded rod, chain or wire ties (rod, chain or wire ties are not supplied with the unit). The unit must be suspended from a structure of sufficient strength to support its weight.

Wire tie suspension is best achieved by using the smaller holes in the fixing brackets.

Chain suspension could use either the smaller or middle size holes.

Thread rod suspension: use the notches in the fixing brackets. An additional pair of locking plates are provided for use with threaded rod suspension. These locking plates should be positioned beneath each fixing bracket to prevent the suspension rods moving. Ensure that the locking nuts are fitted to stop the threaded rod from rotating loose. Before finally replacing the grille, ensure the protective film is removed.

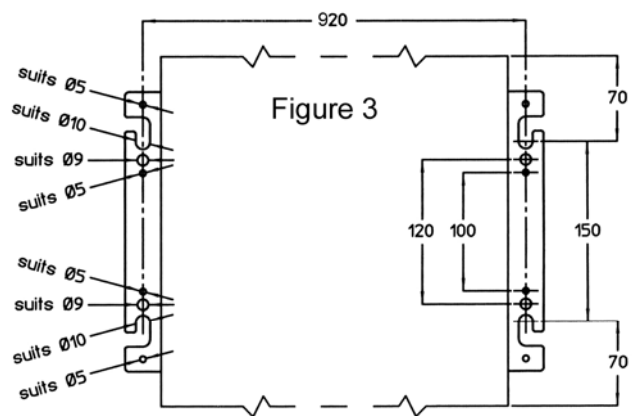
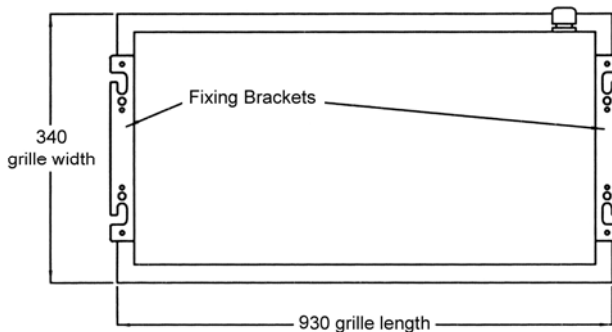
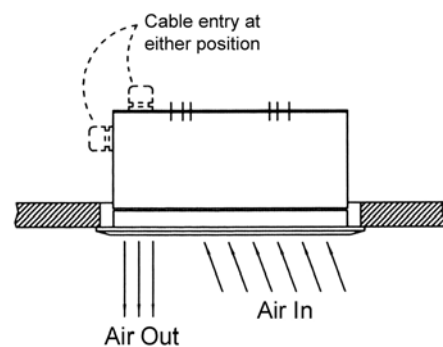
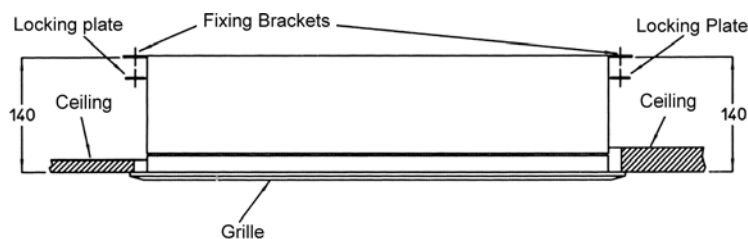

Figure 4.



ELECTRICAL CONNECTIONS

The unit is suitable for connection to a 230/240 Volt 50 Hz single-phase AC supply. The heater consumes 6kW respectively at 240 volts when switched to the full heat position.

RAC6000 6 kW 25A

Units should only be wired by a competent electrician in accordance with the latest edition of the IEE wiring regulations. Ensure that the supply cables and circuit breakers are sufficient for the air curtain being installed.

The appliance should be connected to the supply via a circuit in which there is an all-pole switch.

To gain access to electrical connection the recessed grille must be removed. The grille is secured to the enclosure of the air curtain via 4 cross head screws; see Fig 1. Cable entry may be moved to alternative position if desired.

For safety reasons a sound earth connection must always be made to the unit before it is put to use. The unit should be wired in accordance with IEE Regulations for the Electrical Equipment of Buildings.

NOTE: The unit **MUST** be reliably earthed.

OPERATION

All units are supplied with a remote switch that gives the following functions; On/off & two heat settings. For thermostatic control a room thermostat maybe connected.

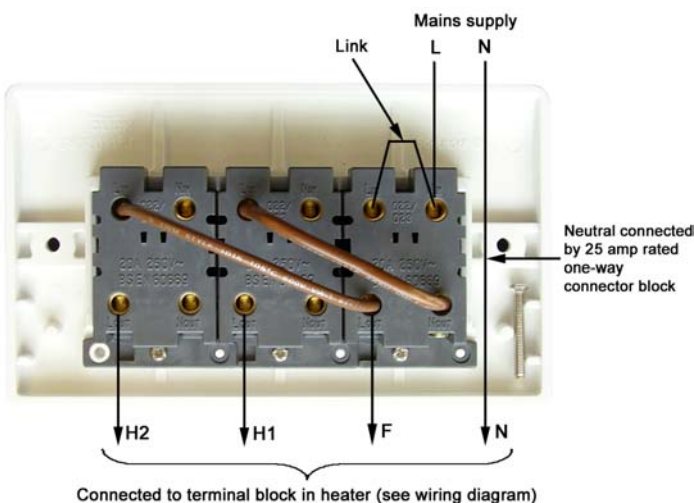

CONTROLS

To switch on the appliance and operate the blower, depress the left-hand switch (marked "FAN").

When the centre switch only (marked with a single bar) is depressed the heat output is 1/3 of full heat. When the right hand switch only (marked with a double bar) is depressed the heat output is 2/3 of full heat. When both the centre switch and the right-hand switch are depressed the full heat output is available.

MAINTENANCE

Always ensure that the main external electricity supply is switched off before attending to the servicing of your Claudgen Screen-Zone heater.

To obtain best results from your heater it is necessary to avoid the build up of dust and dirt within the unit and on the air inlet and discharge grills. For this reason regular cleaning is necessary, paying particular attention to the removal of dirt build up on the rotor blades. A single drop of light oil should be applied to the motor bearing from time to time.

PROTECTION (Thermal Cut out)

The units are protected from overheating in the event of fan failure or an obstruction of the free airflow, by an auto reset thermal cut outs. If this happens the thermal cut outs effectively switches off the appliance. The appliance will not operate until it has cooled down. If this fault re-occurs again, refer to 'fault conditions'.

FAULT CONDITIONS

If the heater will not operate, disconnect it from the mains and arrange for a certified electrician to attend to investigate the reason.

TO REPLACE THE FAN HEATER ASSEMBLY

- Remove the grille.
- Disconnect the internal wiring from the main terminal block.
- Remove the four nuts and washers fixing the fan heater assembly to the back of the case.
- The fan heater assembly can now be eased forward and removed from the heater case.
- Fit replacement fan heater and reassemble in reverse order.

SPARES

It is essential when ordering spares or replacement parts to state the model number and the serial number on the rating plate fixed to the top of the unit.

In the interest of progress the Company reserve the right to vary specifications from time to time without notice. The material listed is offered subject to the Company's General Conditions of Sale, a copy of which can be obtained on request.

NOTE: DO NOT COVER any of the air inlet or outlet grills, at any time.